



CAR BENCH[®]
CAR BENCH INTERNATIONAL SPA

ONLY THE BEST CAN BE NUMBER ONE

ELECTRO POWER CB-EPO1





MINI DOZER FOR ELECTRO POWER

Pulling and pushing system for fast repairing, battery operated - up to 5 ton capacity.

It can be used in confined spaces as it has no electric wire or hydraulic hose

KIT STANDARD:
620 X 420 X 150mm
Weight: 18Kg



MECHANICAL SPREADER FOR ELECTRO POWER GUN

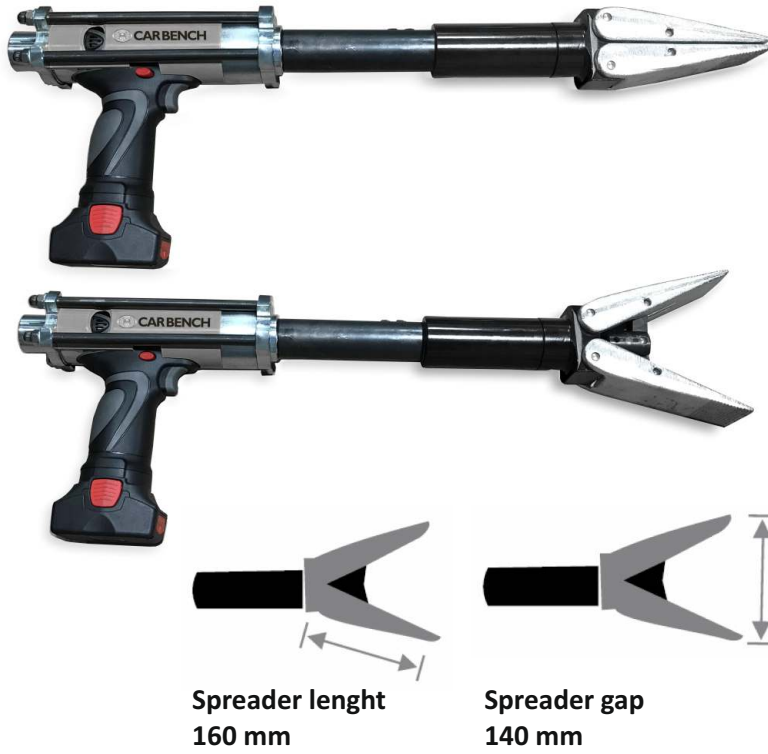

SMART PULLING TOOL FOR ELECTRO POWER



KIT ACCESSORIES

620 X 420 X 150mm
Weight: 20Kg

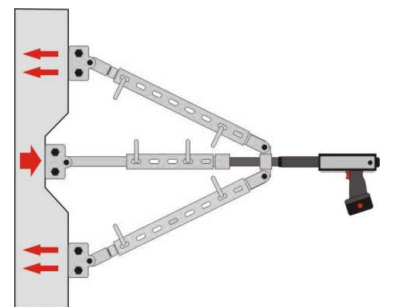
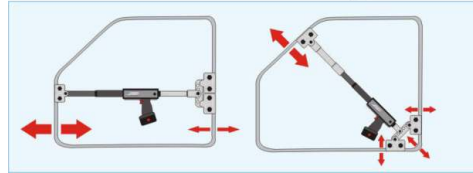
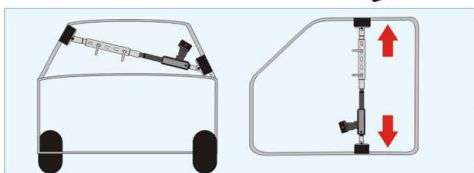
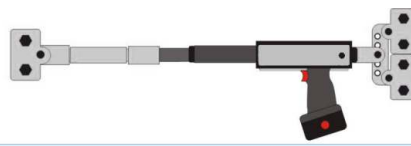
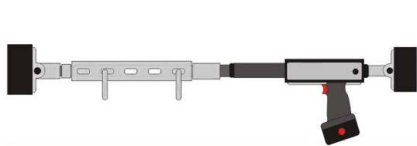
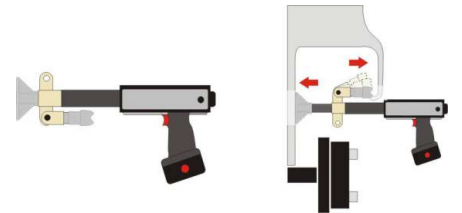
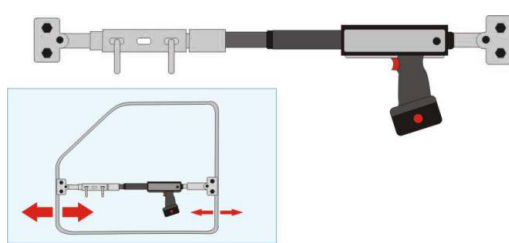
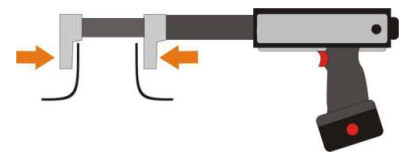
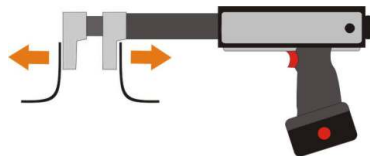

ELECTRO POWER DOZER CB-EP01



TECHNICAL FEATURES

Pulling power	5 ton
Pushing power	5 ton
Piston strokes	130 mm

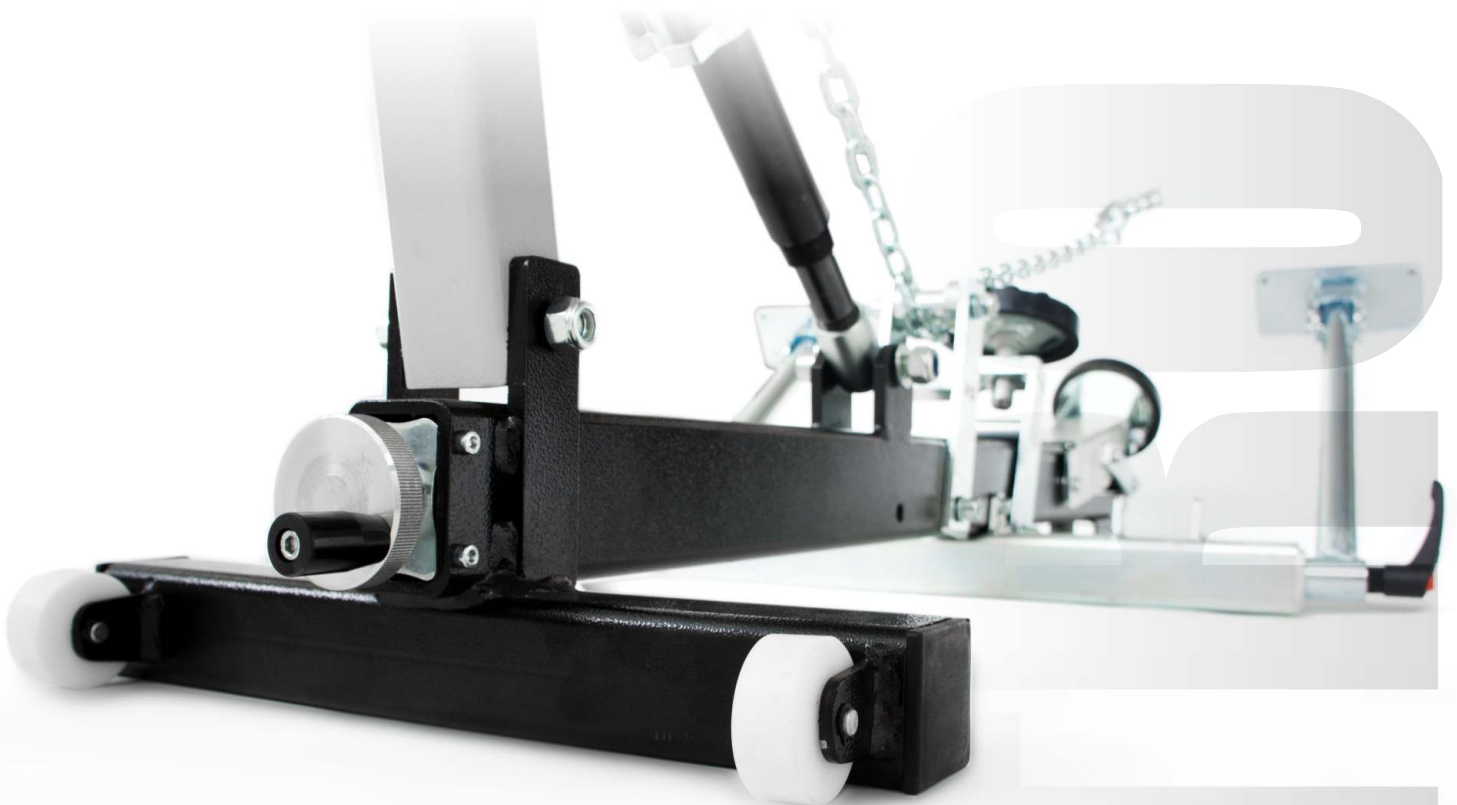

CAR BENCH
TRAINING ACADEMY

REPAIR
METHODS

CAR BENCH
EQUIPMENT TRAINING

CUSTOMIZED
OEM TRAININGS



Car Bench International S.p.A.
Via Dorsale, 22 - 54100 Massa (MS) - ITALY
info@carbench.it - ph. +39 0585 251261
www.carbenchinternational.com